



C Type



E Type

- Suitable for wet locations when used with gasketed covers.
- Federal Specification W-C-586D/A-A 50563.
- Suitable for use in hazardous location applications when installed according to NEC Articles 501-4(b), Class I, Div. 2, (Suitable for use in Class I Zone 2 applications) 502-4 & 5, and 503-3.

Listed File No. E3397

Certified File No. LR11852

FEATURES-SPECIFICATIONS

DURALOY⁵

Applications

To provide access to conductors for pulling, splicing, and maintenance. Threaded for rigid conduit and IMC.

Features

- Tapered threaded hubs (NPT)
- Raintight when used with gasketed covers
- Malleable iron suitable for use in concrete
- Interchangeable with competitive products
- Stainless steel screws on stamped and cast covers

Material/Finish

Copper-free Aluminum
(less than 4/10 of 1%)

- Electrostatically applied powder coating

Duraloy Malleable Iron

- Tri-coat finish of electrozinc, chromate sealant, and electrostatically applied powder coating.

C TYPE CONDUIT BODY										
CATALOG NUMBER		HUB SIZE	DIMENSIONS							VOLUME CU. IN.
KILLARK ALUM.	DURALOY IRON		A	B	C	D	E	F	G	
OC-1	OC-1M	1/2"	5-3/8" (137)	1-3/8" (35)	1-3/8" (35)	1" (25)	3-5/32" (80)	—	5/8" (16)	4.0
OC-2	OC-2M	3/4"	6-1/8" (156)	1-5/8" (41)	1-5/8" (67)	1-7/32" (31)	3-25/32" (96)	—	3/4" (19)	7.0
OC-3	OC-3M	1"	7-1/8" (181)	2" (51)	1-7/8" (48)	1-15/32" (37)	4-17/32" (115)	—	15/16" (24)	12.0
OC-4	OC-4M	1-1/4"	9-1/8" (232)	2-5/8" (67)	2-5/8" (67)	2" (51)	6" (152)	—	1-3/16" (30)	32.0
OC-5	OC-5M	1-1/2"	9-1/4" (235)	2-3/4" (70)	2-5/8" (67)	2" (51)	6" (152)	—	1-3/8" (32)	36.0
OC-6	OC-6M	2"	11-7/8" (302)	3-1/2" (89)	3-1/8" (79)	2-9/16" (65)	8-1/16" (205)	—	1-5/8" (38)	70.0
OC-7	OC-7M	2-1/2"	15-1/8" (384)	4" (102)	4-3/8" (111)	3-11/16" (94)	10-5/8" (270)	—	1-13/16" (54)	153.0
OC-8	OC-8M	3"	15-1/8" (384)	4-3/4" (121)	4-3/8" (111)	3-11/16" (94)	10-5/8" (270)	—	2-3/16" (54)	181.0
OC-9	OC-9M	3-1/2"	18-3/8" (467)	5-1/2" (140)	5-1/2" (140)	4-7/8" (124)	13-1/8" (333)	—	2-1/2" (67)	290.0
OC-0	OC-0M	4"	18-3/8" (467)	5-5/8" (143)	5-1/2" (140)	4-7/8" (124)	13-1/8" (333)	—	2-3/4" (67)	320.0

E TYPE CONDUIT BODY										
CATALOG NUMBER		HUB SIZE	DIMENSIONS							VOLUME CU. IN.
KILLARK ALUM.	DURALOY IRON		A	B	C	D	E	F	G	
OE-1	OE-1M	1/2"	4-5/8" (117)	4-5/8" (117)	1-3/8" (35)	1" (25)	3-9/32" (83)	—	5/8" (16)	4.0
OE-2	OE-2M	3/4"	5-3/8" (137)	5-3/8" (137)	1-5/8" (41)	1-7/32" (29)	3-15/16" (100)	—	3/4" (19)	7.0
OE-3	OE-3M	1"	6-1/4" (159)	6-1/4" (159)	1-7/8" (48)	1-15/32" (35)	4-17/32" (115)	—	7/8" (22)	12.0

Dimensions

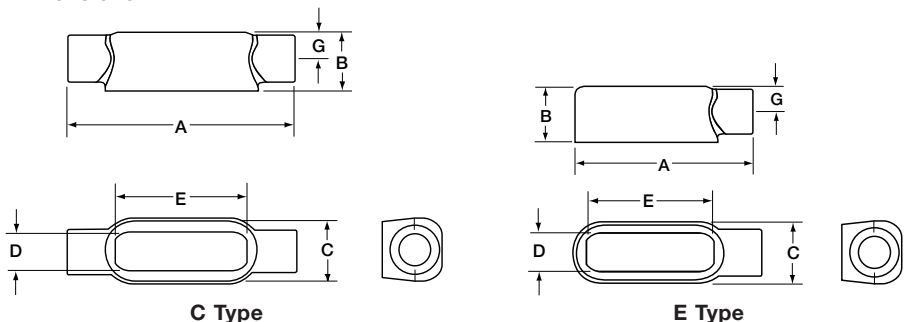



LB Type



LL Type

- Suitable for wet locations when used with gasketed covers.
- Federal Specification W-C-586D/A-A 50563.
- Suitable for use in hazardous location applications when installed according to NEC Articles 501-4(b), Class I, Div. 2, (Suitable for use in Class I Zone 2 applications) 502-4 & 5, and 503-3.

Listed File No. E3397

Certified File No. LR11852

FEATURES-SPECIFICATIONS

DURALOY⁵

See page F16 for Standard Materials & Finish

Dimensions

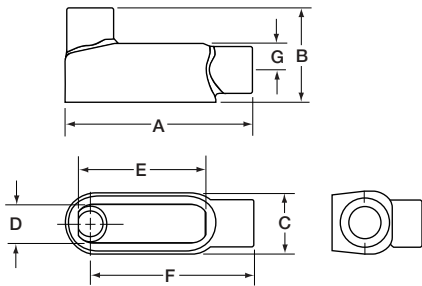

LB Type

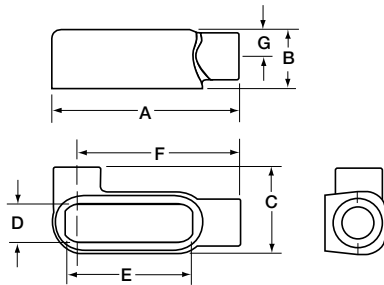

LL Type

LB TYPE CONDUIT BODY										
CATALOG NUMBER KILLARK ALUM.	DURALOY IRON	HUB SIZE	DIMENSIONS							VOLUME CU. IN.
			A	B	C	D	E	F	G	
OLB-1	OLB-1M	1/2"	5-3/32" (129)	2-9/32" (83)	1-3/8" (35)	1" (25)	3-5/32" (80)	4-3/8" (111)	5/8" (16)	4.0
OLB-2	OLB-2M	3/4"	5-3/4" (146)	2-1/2" (64)	1-5/8" (41)	1-7/32" (31)	3-25/32" (96)	4-29/32" (125)	3/4" (19)	7.0
OLB-3	OLB-3M	1"	6-5/8" (168)	2-29/32" (74)	1-7/8" (48)	1-15/32" (37)	4-17/32" (115)	5-23/32" (145)	15/16" (24)	12.0
OLB-4	OLB-4M	1-1/4"	7-1/2" (191)	3-3/16" (81)	2-5/8" (67)	2" (51)	6" (152)	6-13/32" (162)	1-3/16" (30)	32.0
OLB-5	OLB-5M	1-1/2"	9-1/8" (232)	4" (102)	2-5/8" (67)	2" (51)	6" (152)	17-3/4" (451)	1-3/8" (32)	36.0
OLB-6	OLB-6M	2"	11-1/8" (283)	4-13/16" (122)	3-1/8" (79)	2-9/16" (65)	8-1/16" (205)	9-5/32" (233)	1-5/8" (38)	70.0
OLB-7	OLB-7M	2-1/2"	13-15/16" (354)	6-1/8" (156)	4-3/8" (111)	3-11/16" (94)	10-5/8" (270)	11-7/16" (291)	2-1/2" (64)	142.0
OLB-8	OLB-8M	3"	13-15/16" (354)	6-1/2" (165)	4-3/8" (111)	3-11/16" (94)	10-5/8" (270)	11-7/16" (291)	2-3/16" (54)	173.0
OLB-9	OLB-9M	3-1/2"	16-7/8" (429)	7-9/16" (192)	5-1/2" (140)	4-7/8" (124)	13-1/8" (333)	13-3/4" (349)	2-1/2" (67)	292.0
OLB-0	OLB-0M	4"	16-7/8" (429)	7-13/16" (198)	5-1/2" (140)	4-7/8" (124)	13-1/8" (333)	13-3/4" (349)	2-3/4" (70)	324.0
OLB-12*	—	5"	20-1/4" (514)	9-1/4" (234)	7-3/8" (187)	6-7/16" (164)	16-3/16" (411)	17-3/8" (441)	3-5/8" (92)	732.0

*OLB-12 includes cover and gasket.

LL TYPE CONDUIT BODY										
CATALOG NUMBER KILLARK ALUM.	DURALOY IRON	HUB SIZE	A	B	C	D	E	F	G	VOLUME CU. IN.
OLL-1	OLL-1M	1/2"	4-5/8" (117)	1-3/8" (35)	2" (51)	1" (25)	3-5/32" (80)	—	5/8" (16)	4.0
OLL-2	OLL-2M	3/4"	5-3/8" (137)	1-5/8" (41)	2-3/16" (56)	1-7/32" (31)	3-25/32" (96)	—	3/4" (19)	7.0
OLL-3	OLL-3M	1"	6-1/4" (159)	2" (51)	2-9/16" (65)	1-15/32" (37)	4-17/32" (115)	—	15/16" (24)	12.0
OLL-4	OLL-4M	1-1/4"	8-1/8" (206)	2-5/8" (67)	3-1/2" (89)	2" (51)	6" (152)	—	1-3/16" (30)	32.0
OLL-5	OLL-5M	1-1/2"	8-1/8" (206)	2-3/4" (70)	3-1/2" (89)	2" (51)	6" (152)	—	1-3/8" (32)	36.0
OLL-6	OLL-6M	2"	10-9/16" (268)	3-1/2" (89)	4-3/16" (106)	2-9/16" (65)	8-1/16" (205)	—	1-5/8" (38)	70.0
OLL-7	OLL-7M	2-1/2"	13-11/16" (348)	4" (102)	5-3/4" (146)	3-11/16" (94)	10-5/8" (270)	—	1-13/16" (46)	142.0
OLL-8	OLL-8M	3"	13-11/16" (348)	4-3/4" (121)	5-3/4" (146)	3-11/16" (94)	10-5/8" (270)	—	2-3/16" (54)	173.0
OLL-9	OLL-9M	3-1/2"	16-1/2" (419)	5-1/2" (140)	7-1/8" (181)	4-7/8" (124)	13-1/8" (333)	—	2-1/2" (67)	292.0
OLL-0	OLL-0M	4"	16-1/2" (419)	5-5/8" (143)	7-1/8" (181)	4-7/8" (124)	13-1/8" (333)	—	2-3/4" (70)	324.0

- Suitable for wet locations when used with gasketed covers.
- Federal Specification W-C-586D/A-A 50563.
- Suitable for use in hazardous location applications when installed according to NEC Articles 501-4(b), Class I, Div. 2, (Suitable for use in Class I Zone 2 applications) 502-4 & 5, and 503-3.

 Listed File No. E3397

 Certified File No. LR11852



LR Type



T Type

FEATURES-SPECIFICATIONS

DURALOY⁵

See page F16 for Standard Materials & Finish

Dimensions

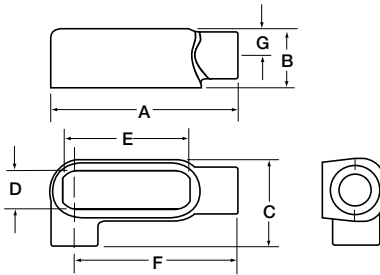

LR Type

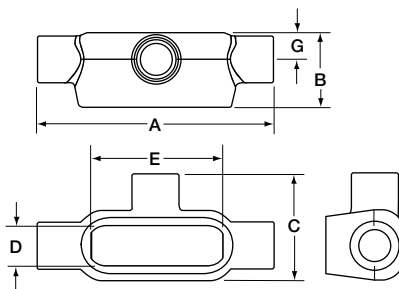

T Type

LR TYPE CONDUIT BODY										
CATALOG NUMBER		HUB SIZE	DIMENSIONS							VOLUME CU. IN.
KILLARK ALUM.	DURALOY IRON		A	B	C	D	E	F	G	
OLR-1	OLR-1M	1/2"	4-5/8" (117)	1-3/8" (35)	2" (35)	1" (25)	3-5/32" (80)	4-3/8" (111)	5/8" (16)	4.0
OLR-2	OLR-2M	3/4"	5-3/8" (137)	1-5/8" (41)	2-3/16" (67)	1-7/32" (31)	3-25/32" (96)	4-29/32" (125)	3/4" (19)	7.0
OLR-3	OLR-3M	1"	6-1/4" (159)	2" (51)	2-9/16" (65)	1-15/32" (37)	4-17/32" (115)	5-23/32" (145)	15/16" (24)	12.0
OLR-4	OLR-4M	1-1/4"	8-1/8" (206)	2-5/8" (67)	3-1/2" (89)	2" (51)	6" (152)	6-13/32" (162)	1-3/16" (30)	32.0
OLR-5	OLR-5M	1-1/2"	8-1/8" (206)	2-3/4" (70)	3-1/2" (89)	2" (51)	6" (152)	17-3/4" (451)	1-3/8" (32)	36.0
OLR-6	OLR-6M	2"	10-9/16" (268)	3-1/2" (89)	4-3/16" (106)	2-9/16" (65)	8-1/16" (205)	9-5/32" (233)	1-5/8" (38)	70.0
OLR-7	OLR-7M	2-1/2"	13-11/16" (348)	4" (102)	5-3/4" (146)	3-11/16" (93)	10-5/8" (270)	11-7/16" (291)	1-13/16" (54)	142.0
OLR-8	OLR-8M	3"	13-11/16" (348)	4-3/4" (121)	5-3/4" (146)	3-11/16" (93)	10-5/8" (270)	11-7/16" (291)	2-3/16" (54)	173.0
OLR-9	OLR-9M	3-1/2"	16-1/2" (419)	5-1/2" (140)	7-1/8" (181)	4-7/8" (124)	13-1/8" (333)	13-3/4" (349)	2-1/2" (67)	292.0
OLR-0	OLR-0M	4"	16-1/2" (419)	5-5/8" (143)	7-1/8" (181)	4-7/8" (124)	13-1/8" (333)	13-3/4" (349)	2-3/4" (67)	324.0

T TYPE CONDUIT BODY										
CATALOG NUMBER		HUB SIZE	DIMENSIONS							VOLUME CU. IN.
KILLARK ALUM.	DURALOY IRON		A	B	C	D	E	F	G	
OT-1	OT-1M	1/2"	5-3/8" (137)	1-3/8" (35)	2" (35)	1" (25)	3-5/32" (80)	—	5/8" (16)	4.0
OT-2	OT-2M	3/4"	6-1/16" (154)	1-5/8" (41)	2-3/16" (67)	1-7/32" (31)	3-25/32" (96)	—	3/4" (19)	7.0
OT-3	OT-3M	1"	7-1/8" (181)	2" (51)	2-9/16" (65)	1-15/32" (37)	4-17/32" (115)	—	15/16" (24)	12.0
OT-4	OT-4M	1-1/4"	9-3/16" (233)	2-5/8" (67)	3-1/2" (89)	2" (51)	6" (152)	—	1-3/16" (30)	32.0
OT-5	OT-5M	1-1/2"	9-3/16" (233)	2-3/4" (70)	3-1/2" (89)	2" (51)	6" (152)	—	1-3/8" (32)	36.0
OT-6	OT-6M	2"	11-5/8" (295)	3-1/2" (89)	4-3/16" (106)	2-9/16" (65)	8-1/16" (205)	—	1-5/8" (38)	70.0
OT-7	OT-7M	2-1/2"	15-1/8" (384)	4" (102)	5-3/4" (146)	3-11/16" (94)	10-5/8" (270)	—	1-13/16" (54)	142.0
OT-8	OT-8M	3"	15-1/8" (384)	4-3/4" (121)	5-3/4" (146)	3-11/16" (94)	10-5/8" (270)	—	2-3/16" (54)	173.0
OT-9	OT-9M	3-1/2"	18-1/8" (460)	5-1/2" (140)	7-1/8" (181)	4-7/8" (124)	13-1/8" (333)	—	2-1/2" (67)	292.0
OT-0	OT-0M	4"	18-1/8" (460)	5-5/8" (143)	7-1/8" (181)	4-7/8" (124)	13-1/8" (333)	—	2-3/4" (67)	324.0

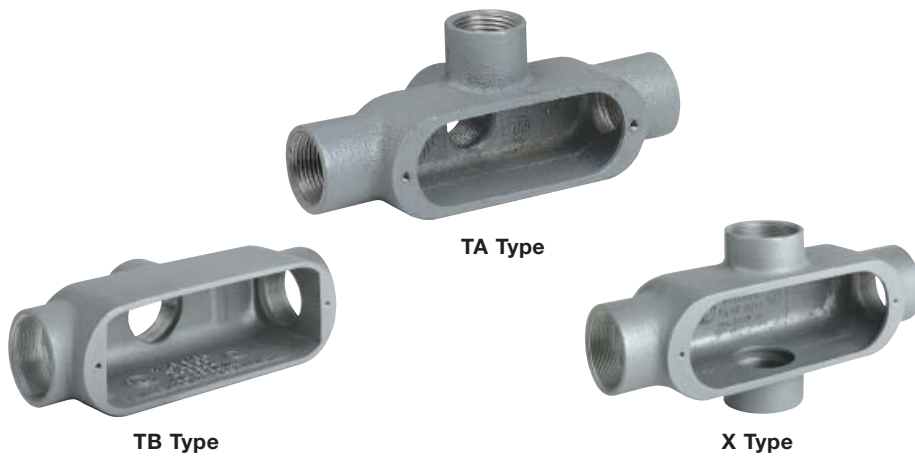

- Suitable for wet locations when used with gasketed covers.
- Federal Specification W-C-586D/A-A 50563.
- Suitable for use in hazardous location applications when installed according to NEC Articles 501-4(b), Class I, Div. 2, (Suitable for use in Class I Zone 2 applications) 502-4 & 5, and 503-3.

Listed File No. E3397

Certified File No. LR11852

FEATURES-SPECIFICATIONS

DURALOY⁵

See page F16 for Standard Materials & Finish

Dimensions

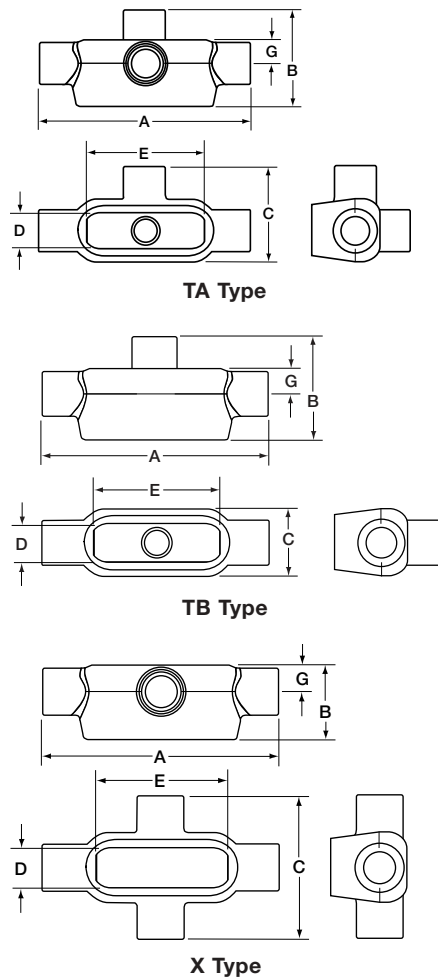

TA TYPE CONDUIT BODY										
CATALOG NUMBER KILLARK ALUM.	DURALOY IRON	HUB SIZE	DIMENSIONS							VOLUME CU. IN.
			A	B	C	D	E	F	G	
OTA-1	OTA-1M	1/2"	5-3/8" (137)	2-1/8" (54)	2" (51)	1" (25)	3-5/32" (80)	—	5/8" (16)	4.0
OTA-2	OTA-2M	3/4"	6-1/16" (154)	2-15/16" (75)	2-3/16" (56)	1-7/32" (29)	3-25/32" (96)	—	3/4" (19)	7.0
—	OTA-3M	1"	7-1/8" (181)	2-11/16" (68)	2-9/16" (65)	1-15/32" (35)	4-17/32" (115)	—	15/16" (24)	12.0

TB TYPE CONDUIT BODY										
CATALOG NUMBER KILLARK ALUM.	DURALOY IRON	HUB SIZE	DIMENSIONS							VOLUME CU. IN.
			A	B	C	D	E	F	G	
OTB-1	OTB-1M	1/2"	5-3/8" (137)	2-1/8" (54)	1-5/16" (33)	1" (25)	3-5/32" (80)	—	5/8" (16)	4.0
OTB-2	OTB-2M	3/4"	6-1/16" (160)	2-5/16" (59)	1-9/16" (40)	1-7/32" (31)	3-25/32" (96)	—	3/4" (19)	7.0
OTB-3	OTB-3M	1"	7-1/8" (181)	2-11/16" (68)	1-13/16" (46)	1-15/32" (37)	4-17/32" (115)	—	15/16" (24)	12.0
OTB-4	OTB-4M	1-1/4"	9-3/16" (233)	3-9/16" (64)	2-1/2" (64)	2" (51)	6" (152)	—	1-3/16" (30)	32.0
OTB-5	OTB-5M	1-1/2"	9-3/16" (233)	3-3/4" (92)	2-1/2" (64)	2" (51)	6" (152)	—	1-3/8" (35)	36.0
OTB-6	OTB-6M	2"	11-5/8" (295)	4-5/8" (117)	3-1/8" (79)	2-9/16" (65)	8-1/16" (205)	—	1-5/8" (41)	70.0

X TYPE CONDUIT BODY										
CATALOG NUMBER KILLARK ALUM.	DURALOY IRON	HUB SIZE	DIMENSIONS							VOLUME CU. IN.
			A	B	C	D	E	F	G	
OX-1	OX-1M	1/2"	5-3/8" (137)	1-3/4" (44)	1-11/16" (43)	1" (25)	3-5/32" (80)	—	5/8" (16)	4.0
OX-2	OX-2M	3/4"	6-1/16" (160)	2" (51)	2-7/8" (73)	1-7/32" (31)	3-25/32" (96)	—	3/4" (19)	7.0
OX-3	OX-3M	1"	7-1/8" (181)	2-1/4" (57)	3-3/8" (86)	1-15/32" (37)	4-17/32" (115)	—	15/16" (24)	12.0
OX-4	OX-4M	1-1/4"	9-3/16" (233)	2-9/16" (65)	4-1/2" (114)	2" (51)	6" (152)	—	1-3/16" (30)	32.0
OX-5	OX-5M	1-1/2"	9-3/16" (233)	2-3/4" (70)	4-1/2" (114)	2" (51)	6" (152)	—	1-3/8" (35)	36.0
OX-6	OX-6M	2"	11-5/8" (295)	3-3/8" (85)	5-1/4" (133)	2-9/16" (65)	8-1/16" (205)	—	1-5/8" (41)	70.0



Aluminum and Steel Stamped Covers



Neoprene Gasket



Cast Iron Covers



Fiber Gasket

- Suitable for wet locations when used with gasketed covers.
- Federal Specification W-C-586D / A-A 50563.
- Suitable for use in hazardous location applications when installed according to NEC Articles 501-4(b), Class I, Div. 2, (Suitable for use in Class I Zone 2 applications) 502-4 & 5, and 503-3.



Listed File No. E3397



Certified File No. LR11852

FEATURES-SPECIFICATIONS

DURALOY® 5

Stamped Material/Finish

Copper-free Aluminum

(less than 4/10 of 1%)

- Natural finish
- 300 Series stainless steel screws

Galvanized Steel

- Natural finish
- 300 Series stainless steel screws

Cast Material/Finish

Duraloy Malleable Iron

- Tri-coat finish of electrozinc, chromate sealant, and electrostatically applied powder coating
- 300 Series stainless steel screws

Material/Finish

- Neoprene or fiber

ALUMINUM AND STEEL STAMPED COVERS					
CATALOG NUMBER		HUB SIZE	DIMENSIONS		
KILLARK ALUMINUM	STEEL		LENGTH	WIDTH	HEIGHT
OL-10	OL-10M	1/2"	3-15/16"(100)	1-3/8"(35)	3/8"(10)
OL-20	OL-20M	3/4"	4-5/8"(117)	1-5/8"(41)	3/8"(10)
OL-30	OL-30M	1"	5-3/8"(137)	1-7/8"(48)	5/8"(16)
OL-450	OL-45M	1-1/4"	7-3/16"(183)	2-5/8"(67)	5/8"(16)
OL-450	OL-45M	1-1/2"	7-3/16"(183)	2-5/8"(67)	5/8"(16)
OL-60	OL-60M	2"	9-1/2"(241)	3-1/8"(79)	5/8"(16)
OL-780	OL-78M	2-1/2"	12-1/4"(311)	4-3/8"(111)	5/8"(16)
OL-780	OL-78M	3"	12-1/4"(311)	4-3/8"(111)	5/8"(16)
OL-900	OL-90M	3-1/2"	14-7/8"(378)	5-1/2"(140)	5/8"(16)
OL-900	OL-90M	4"	14-7/8"(378)	5-1/2"(140)	5/8"(16)

CAST IRON COVERS				
CATALOG NUMBER	HUB SIZE	DIMENSIONS		
		LENGTH	WIDTH	HEIGHT
OL-10CM	1/2"	3-15/16"(100)	1-3/8"(35)	3/8"(10)
OL-20CM	3/4"	4-5/8"(117)	1-5/8"(41)	3/8"(10)
OL-30CM	1"	5-3/8"(137)	1-7/8"(48)	5/8"(16)
OL-45CM	1-1/4"	7-3/16"(183)	2-5/8"(67)	5/8"(16)
OL-45CM	1-1/2"	7-3/16"(183)	2-5/8"(67)	5/8"(16)
OL-60CM	2"	9-1/2"(241)	3-1/8"(79)	5/8"(16)
OL-78CM	2-1/2"	12-1/4"(311)	4-3/8"(111)	5/8"(16)
OL-78CM	3"	12-1/4"(311)	4-3/8"(111)	5/8"(16)
OL-90CM	3-1/2"	14-7/8"(378)	5-1/2"(140)	5/8"(16)
OL-90CM	4"	14-7/8"(378)	5-1/2"(140)	5/8"(16)

GASKETS		
HUB SIZE	CATALOG NUMBER	
	NEOPRENE	FIBER
1/2"	OLK-1RG	OLK-1VG
3/4"	OLK-2RG	OLK-2VG
1"	OLK-3RG	OLK-3VG
1-1/4"	OL-45-RG	OL-45-VG
1-1/2"	OL-45-RG	OL-45-VG
2"	OL-6-RG	OL-6-VG
2-1/2"	OL-78-RG	OL-78-VG
3"	OL-78-RG	OL-78-VG
3-1/2"	OL-90-RG	OL-90-VG
4"	OL-90-RG	OL-90-VG

